

**Abstract:** It was ten years ago in Rochester, New York that the first SPIDER was built. This simple acronym belies the subtleties of its inner workings; Spectral Phase Interferometry for Direct Electric-field Reconstruction (the “f” in field conveniently missed the cut) is a device that measures ultrashort pulses, utilizing spectral shearing interferometry and directly recovering the spectral phase. The very first SPIDER apparatus occupied nearly half an optical table, used a scanning monochromator, and had no computerized inversion routine. In the intervening decade, SPIDER has grown up. It has found a strong foothold in ultrafast laboratories throughout the world. Multiple groups have found useful new applications with this vital measurement tool, while others have contributed to the improvement of SPIDER itself, reaching to ever shorter pulses, new wavelength regimes, and making devices more sensitive, robust, smaller and faster. It also adapts to a field of research that changes rapidly. It was first designed to track and quantify the remaining spectral phase in a pulse to perfect its compression. In ten years, with the advent of pulse shapers, the real benefits of field diagnostics are becoming apparent. We have shifted away from the race towards the shortest IR pulse to a wide use of complex shaped pulses in almost every spectral range from far IR to XUV. But the quest of the shortest pulse is not over and new compression techniques utilize really broad spectra that are highly structured. All these applications provide new challenges for characterization techniques.

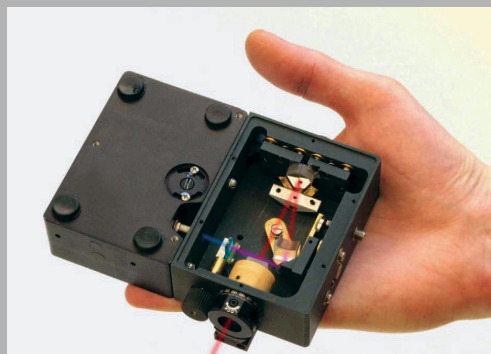

The latest generation of ultra-compact pulse characterization devices can come in handy. A micro-SPIDER for measuring the 30 fs pulses from a standard Ti:Sapphire laser system is shown

© 2008 by Astro Ltd.  
Published exclusively by WILEY-VCH Verlag GmbH & Co. KGaA

## SPIDER: A decade of measuring ultrashort pulses

M.E. Anderson,<sup>1,\*</sup> A. Monmayrant,<sup>2</sup> S.-P. Gorza,<sup>3</sup> P. Wasylczyk,<sup>4</sup> and I.A. Walmsley<sup>5,\*</sup>

<sup>1</sup> Dept. of Physics, San Diego State University, 5500 Campanile Dr., San Diego, CA 92182-1233, USA

<sup>2</sup> LAAS-CNRS, 7 avenue du Colonel Roche, 31077 Toulouse, Cedex 4, France

<sup>3</sup> Service OPERA-photonique, Universit libre de Bruxelles (ULB), 50 Avenue F.D. Roosevelt, CP194/5 B-1050 Bruxelles, Belgium

<sup>4</sup> Institute of Experimental Physics, Warsaw University, ul. Hoza 69, 00-681 Warszawa, Poland

<sup>5</sup> Clarendon Laboratory, University of Oxford, Parks Road, Oxford OX1 3PU, United Kingdom

Received: 25 November 2007, Revised: 10 December 2007, Accepted: 12 December 2007

Published online: 10 January 2008

**Key words:** ultrafast laser characterization; ultrafast optics; ultrafast metrology; spider

**PACS:** 42.55.-f, 95.75.Kk, 06.00.00, 42.65.-k, 42.65.Re, 42.65.Ky

### 1. Ultrashort pulses

Ultrashort pulsed lasers have been a driving force in research for the past 25 years. The usefulness of ultrashort pulses is three-fold. First, their femtosecond temporal du-

ration allows access to physical events that happen on sub-picosecond timescales.

Second, their incredibly high field strengths permit nonlinear interactions with tabletop laser systems. And third, their broad and coherent spectrum permits the con-

\* Corresponding author: e-mail: [matt@sciences.sdsu.edu](mailto:matt@sciences.sdsu.edu); [walmsley@physics.ox.ac.uk](mailto:walmsley@physics.ox.ac.uk)

control of quantum systems through their interaction with shaped pulses (coherent control and optimal control). The temporal brevity of ultrafast laser pulses has steadily improved in the last few decades. Simultaneously with this progress have come better techniques for characterizing these pulses.

But there is more to pulse measurement than diagnosis. The electromagnetic field is the fundamental entity in Maxwell's theory and its determination therefore provides the maximum possible information about any system that light is used to probe. Measuring the field is a basic protocol for optical science. In fact, the research area of pulse characterization has taken on a life of its own, particularly with new advances in ultrashort pulse generation, such as near-single cycle visible and attosecond pulses; the ubiquity of pulse shapers and applications to coherent control; and the march into new wavelength regimes, from the XUV to the mid IR that open up new types of spectroscopy across many different systems. In this review, we present the SPIDER method for pulse characterization and its various incarnations.

## 2. Time vs. frequency

An ultrashort pulse may be equally well represented in the time or frequency picture. In time, the pulse consists of a short burst of electromagnetic waves under an envelope. This is the most obvious way of describing an ultrashort pulse, but also the least practical as, by definition of an ultrashort pulse, there do not exist any detectors fast enough to observe this temporal envelope. In the spectral domain, an ultrashort pulse is characterized by a broad spectral intensity or energy spectrum  $I(\omega)$ , where  $\omega$  is the optical angular frequency. A broad spectrum is necessary but not sufficient to ensure a short pulse. In effect, one can find a thermal source or a LED that has the same spectrum as a 10 fs visible pulse. The spectral intensity only gives the relative intensity of the different spectral components, or spectral modes, that compose the light. It gives no information on the relative phase between these modes. In a thermal source, this relative phase is random and an individual pulse is not formed in the time domain; rather the time intensity fluctuates in short bursts spread over a long time. In an ultrashort pulse, there exists a well-defined phase relation between these modes. If, for example, the relative phase between adjacent modes is zero or constant, all the modes add constructively at the same point in time and the shortest pulse achievable for a given spectrum is formed around this point. If this relative phase is not constant, but in fact varies between frequency slices, the different modes interfere constructively at different points in time. This induces a smearing (or broadening) of the temporal pulse, but also a variation of the central wavelength under the temporal envelope (the so-called "chirp"). The phase of the different spectral modes, the spectral phase, thus plays a major role in the temporal profile of a light pulse. Knowing both the spectrum and the spectral phase

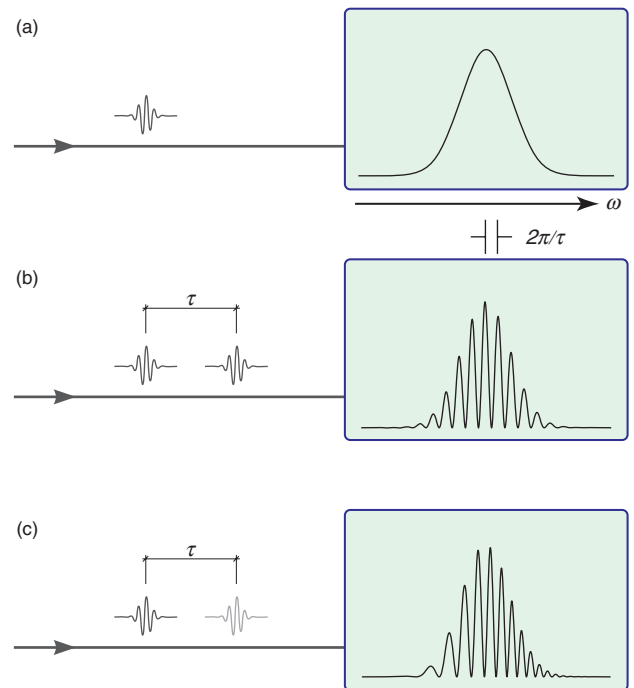
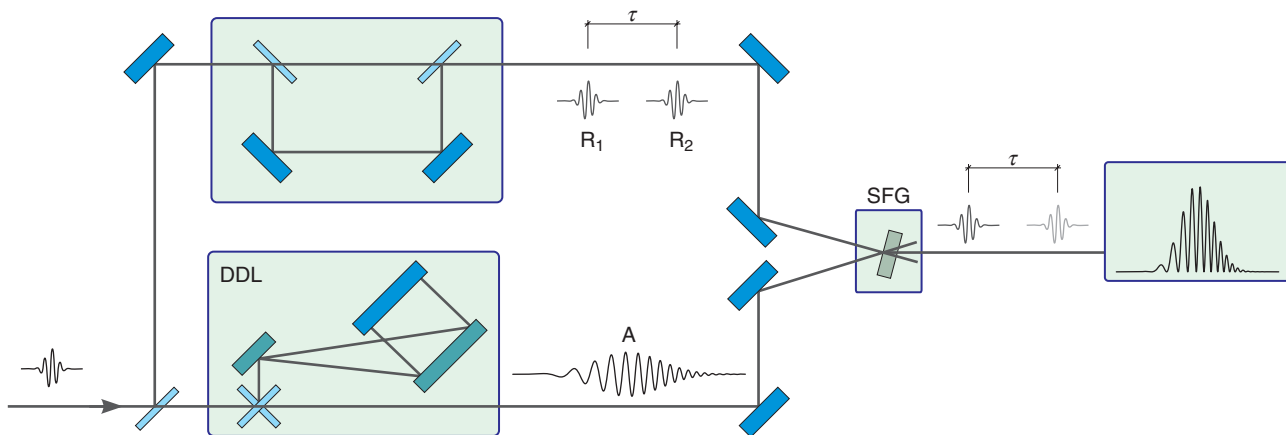

**Figure 1** (online color at [www.lphys.org](http://www.lphys.org)) (a) A single ultrashort pulse entering the spectrometer creates a Gaussian-like intensity profile. (b) Two pulses separated by  $\tau$  create a spectral interference pattern. (c) Two sheared pulses separated in time by  $\tau$  and in central frequency by  $\Omega$  create a SPIDER interferogram

allows one to reconstruct the temporal evolution of the light pulse. In fact, for a given spectrum, the spectral phase entirely determines the temporal profile of an ultrashort pulse. The field is fully characterized by either the spectral amplitude and the spectral phase or the temporal amplitude and temporal phase. The information is identical, and the two pictures may be converted by means of the Fourier transform. SPIDER works in the frequency domain to recover the spectral phase and the spectral amplitude, but the temporal field is, of course, directly related.

## 3. Interferometry

Recovering the phase of light fields is most easily accomplished through interference. The phase then manifests itself as modulations of the intensity pattern in a square law detector. If a single pulse enters a spectrometer, a broad spectrum is recorded, see Fig. 1a. If instead two pulses in time separated by  $\tau$  enter the spectrometer, the spectral intensity pattern shows interference fringes as seen in Fig. 1b (this bothers many students, the question of how electric fields separated in time can interfere; we will leave that to the reader). If two pulses of slightly different center frequency (but otherwise identical) enter the spectrometer, however, the fringe pattern may change, as in



**Figure 2** (online color at [www.lphys.org](http://www.lphys.org)) The classic SPIDER setup — two pulse replicas ( $R_1$  and  $R_2$ ), delayed by  $\tau$ , are prepared together with an ancillary stretched pulse ( $A$ ). This stretched pulse is created in a dispersive delay line (DDL) which consists of two gratings (green) and a mirror (blue). All three pulses are subsequently mixed in a sum frequency generation (SFG) process to generate a pair of spectrally sheared copies of the measured pulse. Spectral fringes are recorded with a spectrometer. This connects to a computer, which extracts the phase from this interferogram

Fig. 1c. The fringes may spread out, for example, or become non-uniformly spaced. These subtle changes are due to the underlying spectral phases of each individual pulse. Let the complex field of the pulse be  $\sqrt{I(\omega)} \exp\{i\phi(\omega)\}$ . The frequency shifted (or *sheared*) pulse therefore has a field  $\sqrt{I(\omega + \Omega)} \exp\{i\phi(\omega + \Omega)\}$ . When these pulses are mixed in a spectrometer the resulting interferogram is:

$$S(\omega) = I(\omega) + I(\omega + \Omega) + \sqrt{I(\omega)I(\omega + \Omega)} \cos[\phi(\omega) - \phi(\omega + \Omega) + \omega\tau],$$

where  $\tau$  is a delay introduced between the pulse and its replica. This equation describes the backbone of SPIDER: spectral shearing interferometry, a technique whereby two fields with slightly different central frequency interfere in a spectrometer, creating an interferogram, as shown in Fig. 1. Fig. 1b refers to the case where two identical pulses delayed by  $\tau$  enter the spectrometer. Or in the above equation, the case when  $\Omega = 0$ . In this case, access to the spectral phase is not possible, since  $\phi(\omega) - \phi(\omega + \Omega) = 0$  and the argument of the cosine reduces to  $\omega\tau$ . Thus the fringe periodicity indicates the delay  $\tau$ . When  $\Omega \neq 0$ , however, as in the case of Fig. 1c, the cosine argument becomes  $\phi(\omega) - \phi(\omega + \Omega) + \omega\tau$ . In principle, with a knowledge of  $\Omega$  and  $\tau$ , it is possible to characterize the spectral phase. More precisely, what is recovered is the gradient of the spectral phase, and the spectral phase is revealed through concatenation or integration. Neglected is a linear spectral phase term which corresponds to an unimportant temporal delay of the pulse and a constant phase corresponding to the carrier-envelope offset. This ability of spectral shearing interferometry to reveal the spectral phase was originally pointed out by Zubov and Kuznetsova in 1991 [1] and developed independently by Wong and Walmsley [2].

## 4. SPIDER

SPIDER implements spectral shearing interferometry using nonlinear optics. It provides a means for recovering the full pulse information for pulses of  $10^{-11}$  seconds or less duration. The amplitude information is recorded from a spectrum measurement. The spectral phase is extracted from the interferogram, since information about the underlying spectral phase is encoded into the fringe spacing of the interferogram. For instance, the fringes will slightly spread out or shrink with a chirped pulse (depending on the sign of chirp and temporal delay). SPIDER compares the recorded interferogram to a calibrated reference interferogram (one recorded with no spectral shear) and calculates the spectral phase. The key to SPIDER's operation is creating this spectral shear. Since the shear needs to be a reasonable percentage of the pulse's spectral bandwidth, and ultrashort bandwidths are tens of THz wide, achieving the requisite spectral shear is most easily accomplished with nonlinear optical techniques.

The original SPIDER, as first demonstrated by Iaconis and Walmsley [3], and illustrated in Fig. 2, employed nonlinear sum frequency generation (SFG) to generate the spectral shear. An ultrafast pulse was split into two arms. In one arm the beam was sent to a grating pair which stretched the pulse by adding a large negative chirp. The other arm went to a mismatched Michelson interferometer which generated a pulse pair. The pulse pair and the chirped pulse were upconverted in a nonlinear optical crystal, generating a pair of blue pulses. Since each pulse in the fundamental pulse pair overlapped with a different quasi-monochromatic temporal slice of the chirped pulse, the SFG blue pulses had different central frequency, the requisite spectral shear. These blue pulses were then sent to

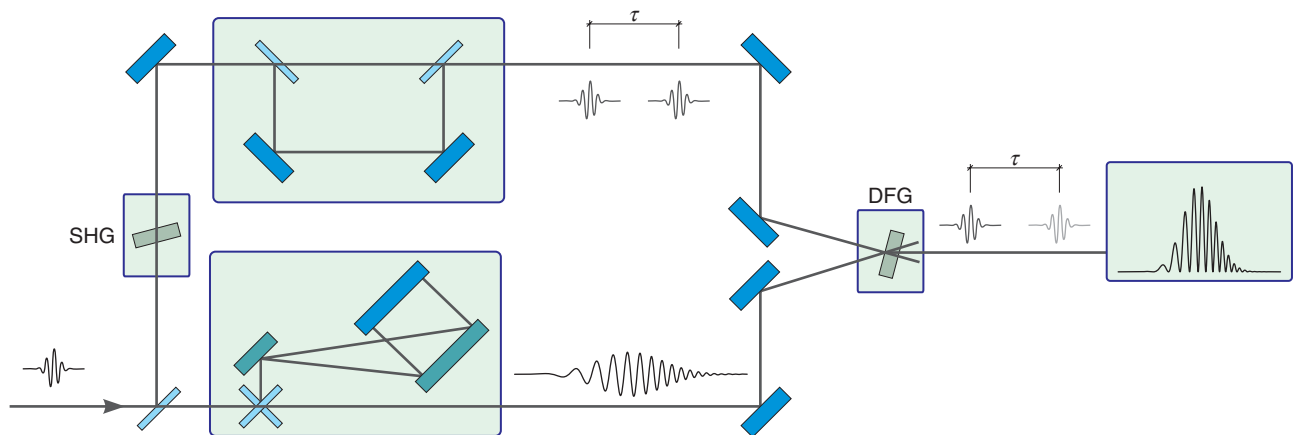

**Figure 3** (online color at [www.lphys.org](http://www.lphys.org)) The down-conversion (DC) SPIDER setup — the pulse generated in the second harmonic generation (SHG) process can be replicated with a required spectral shear by difference frequency generation (DFG) with a stretched ancilla

a scanning monochromator and recorded as an interferogram. In order to recover the spectral phase from the interferogram, an inversion algorithm is used. The originally conceived inversion algorithm is still the dominant routine used. It is straightforward and involves Fourier transforms and filters; the process is non-iterative and unambiguous. Its implementation is described in [3] and [4] and a sample code is presented online [5]. The inversion routine requires proper calibration of the zero-shear phase and spectral shear  $\Omega$ , and calibration issues are described in [3, 4, 6–8]. Roughly speaking, for a five femtosecond pulse of close to transform-limited duration – that is with very little variation in phase across the spectrum, a calibration error of 2.5% turns into a pulse duration error of 10% [9]. The inversion algorithm returns the spectral phase, and this combined with the spectral amplitude, give the full electric field, either in the frequency or time domain.

## 5. SPIDER designs

Even though it has only been a decade since the first implementation of SPIDER [3], there has been considerable success by research groups worldwide to extend SPIDER's capabilities. The following discussion is meant to highlight some of those efforts. For instance, a minor modification of the original SPIDER design permitted characterization of femtosecond blue pulses [10]. This is of interest since measuring ultrashort UV pulses is difficult because nonlinear crystals have difficulty performing up-conversion of UV light (for example, BBO has an absorption band edge near 200 nm). Since many ultrashort blue pulses originate from the doubling of ultrashort NIR pulses, the original laser pulse may be used to characterize the doubled pulse. Thus by performing downconversion (instead of upconversion), UV pulses were characterized by a device shown in

Fig. 3. This highlights an important issue: the chirped ancillary pulse for SPIDER need not originate from the test pulse itself. Indeed since no interferometric stability is required between the test and ancilla, a separate source for the latter is possible provided it is temporally overlapped with the test pulse. This opens up the possibility of measuring a wide variety of wavelengths and pulse durations.

There was also strong motivation to apply SPIDER to the latest class of ultrashort lasers, those that generate sub-10 fs pulses. The limiting factor in the original design was the phase matching bandwidth of the nonlinear optical crystal that scales with the inverse of the crystal thickness. Gallman et al. [11] circumvented this problem by employing a very thin (30  $\mu\text{m}$ ) BBO crystal to deal with the enormous bandwidth of sub-10 fs pulses. More recently sub-5 fs pulses from a two-stage hollow-fiber compressor were successfully measured with an adapted SPIDER apparatus [12]. Another limiting factor arises out of any extra dispersion on one of the two replica used for the SPIDER measurement which distorts the interferogram. This dispersion mismatch typically occurs when splitting the unknown pulse into two time-delayed replicas, since the two replicas travel through different amounts of beamsplitter glass. However, by calibrating the spectrograph at the second harmonic, the dispersion mismatch in the pulse pair is automatically compensated for [13]. Baum et al. have developed zero-added phase SPIDER (ZAP-SPIDER), which introduces no phase distortion of the pulse prior to the up-conversion [14, 15]. In this method, instead of mixing in the nonlinear crystal two delayed replica with an ancillary chirped pulse, the pulse to measure is directly sent into the crystal together with two delayed ancillas to end up with the two sheared and delayed replica. This is shown in Fig. 4.

Ultrashort pulses are often synonymous with strongly modulated spectra. Small fringe periodicity in the SPIDER

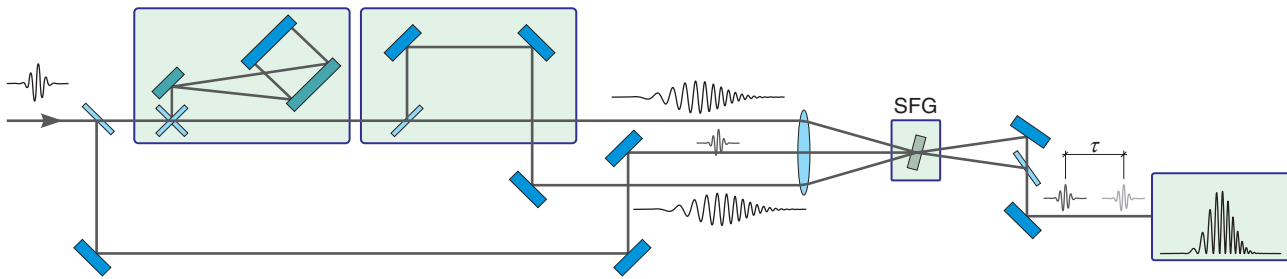

**Figure 4** (online color at [www.lphys.org](http://www.lphys.org)) Zero additional phase (ZAP) SPIDER setup — a pair of stretched ancillas is produced and mixed with the measured pulse. In fact, there are five beams exiting the crystal and we only show the unconverted beams for simplicity. The mirrors after the crystal may be used to adjust  $\tau$

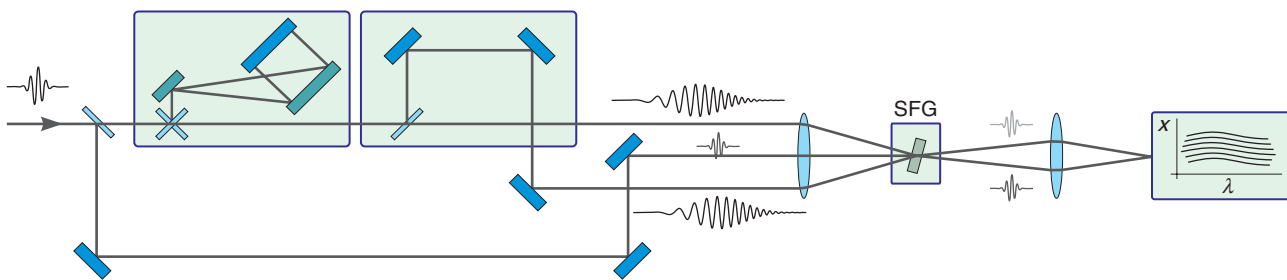

**Figure 5** (online color at [www.lphys.org](http://www.lphys.org)) Spatially encoded arrangement (SEA) SPIDER setup — the measured pulse upconverts with a pair of stretched, delayed ancillas. Spectral interference between the resulting, spectrally sheared and spatially tilted replicas is resolved in position ( $x$ ) and wavelength ( $\lambda$ ) with an imaging spectrometer

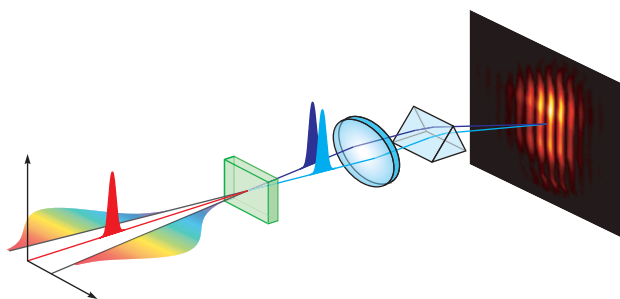
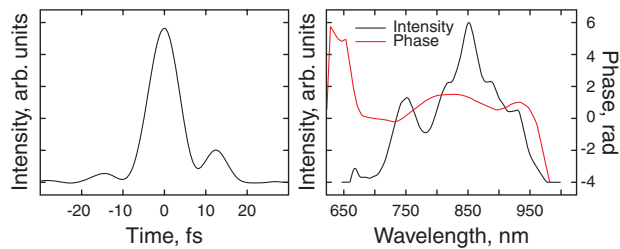

**Figure 6** (online color at [www.lphys.org](http://www.lphys.org)) SEA-SPIDER apparatus and recovered pulse showing temporal intensity (left inset), spectrum and spectral phase (right inset). The shape of the fringes indicate the spectral phase derivative, providing an intuitive diagnostic

interferogram is then required to properly encode the spectral phase. By virtue of the Whittaker-Shannon (WS) sampling theorem, this spectral modulation inherently limits the bandwidth and the complexity of the pulse spectrum that can be characterized with a spectrometer of given resolution. Two methods have therefore been recently proposed to overcome this limitation. The *spatially encoded arrangement for SPIDER* (SEA-SPIDER) is similar to ZAP-SPIDER, but instead of interfering in time, the blue replicas interfere in space. This is shown in Fig. 5, where the spectral phase information is encoded in a spatial interference pattern permitting sampling at the WS limit and, at the same time, it can characterize space-time coupling, a common effect in ultrafast experiments [16]. Fig. 6 shows a measured sub-10 fs pulse from a SEA-SPIDER apparatus [17]. An additional feature of this method is the intuitive nature of the interferogram. The shape of the fringes reveals directly the spectral phase derivative; for example, a tilt of the fringes indicates a linear spectral chirp, whereas curvature of the fringes indicates higher order spectral phase terms. Birge's method on the other hand records a two-dimensional interferogram by recording the spectrum of two synchronized sheared replica of the unknown pulse for various relative phase between them [18].

The simplicity of SPIDER's inversion algorithm means that computers of even modest speed can perform

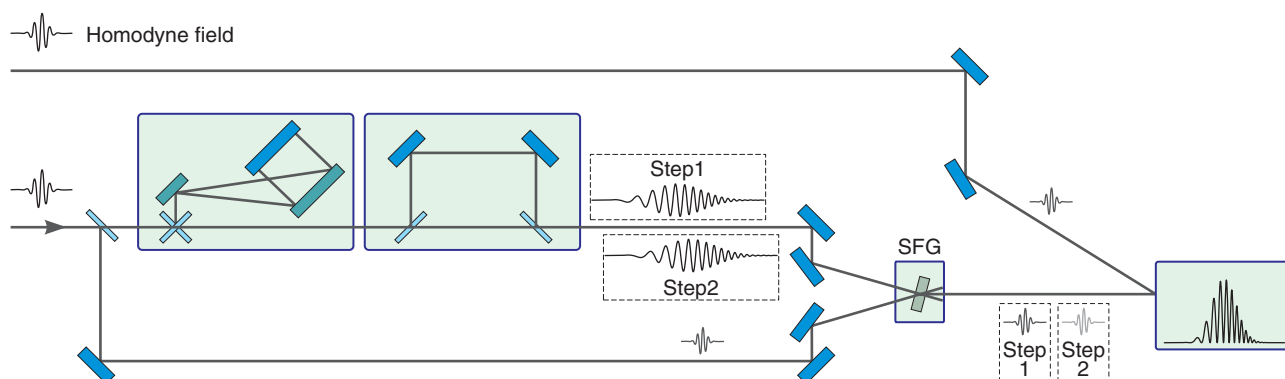

**Figure 7** (online color at [www.lphys.org](http://www.lphys.org)) The homodyne optical technique (HOT) SPIDER setup — the measurement consists of two steps: in each of them, one of the frequency sheared replicas of the measured pulse interferes spectrally with the same homodyne field

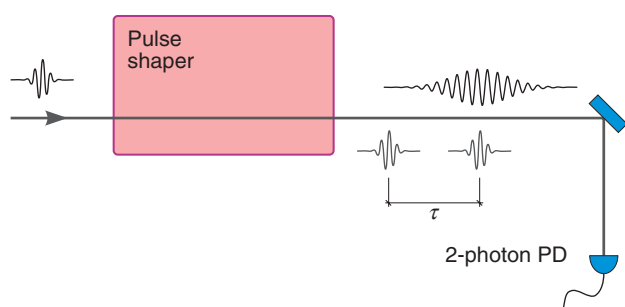

**Figure 8** (online color at [www.lphys.org](http://www.lphys.org)) Time domain homodyne optical technique (TD-HOT) SPIDER setup — a sequence of three pulses is generated in a pulse shaper. The two photon absorption signal is recorded from the photodiode PD as a function of the delay  $\tau$  and phase between one of the replicas and (unchirped) ancilla

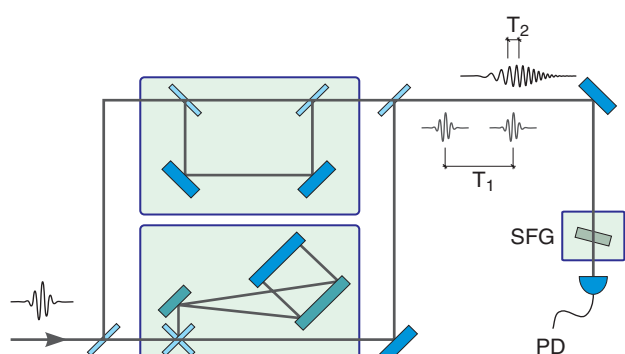

**Figure 9** (online color at [www.lphys.org](http://www.lphys.org)) Time domain homodyne optical technique (TD-HOT) SPIDER setup with conventional optics — a sequence of three pulses is generated in an interferometer and a stretcher. The sum frequency signal is recorded from the photodiode PD as a function of the delays  $T_1$  and  $T_2$  between the three pulses

the inversion quickly (computers love fast Fourier transforms). The limiting factor was the data collection, but with the incorporation of linear array CCD spectrometers, acquiring data moved into real-time [19]. This demonstration also included real-time visual feedback for optimizing the laser output from the CPA's compressor (see movies in reference [19]). For many research laboratories worldwide, this is simply the goal: to generate the shortest pulse possible with their ultrafast laser system. Since this corresponds to a flat spectral phase, simply monitoring SPIDER's recorded spectral phase is a good indicator of this compression. Video update rates are valuable for hands-on optimization, but many amplified laser systems operate at kilohertz repetition rates, and having a record of every laser pulse is rather beneficial, in order to understand the fluctuations of pulse shapes over the experimental ensemble [20], or so that data can be sorted by pulse shape and subtle effects in the signal revealed. Kornelis et al. were able to record SPIDER traces at 1 kHz by using two fast line-scan CCD cameras for the spectrum and the interferogram [21]. Another advantage of SPIDER is its ability to reconstruct the spectral phase even in the presence of noise [22]. Since the spectral phase is hidden in the spacing of the interference fringes, the overall visibility of those fringes is not critical. In fact, it was demonstrated that SPIDER is excellent at recovering the spectral phase with 10% noise, or with low resolution detectors, even down to one-bit [23].

To get pulse information on low-power pulses, it is possible to combine the weak signal with a strong ancillary chirped pulse. In a technique called M-SPIDER, similar to DC-SPIDER, the local oscillator (LO) is used to generate an intense chirped pulse to be upconverted with two weak replica of the pulse to characterize [24]. In another approach called HOT-SPIDER, shown in Fig. 7, a local oscillator is used to heterodyne detect the sheared replicas [25]. The LO is generated by frequency doubling a short pulse. In this design the weak test pulse is not replicated. It is sheared by upconversion with a chirped

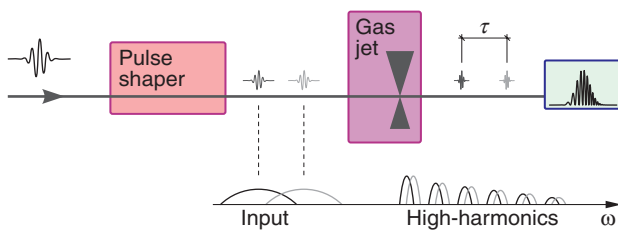

**Figure 10** (online color at [www.lphys.org](http://www.lphys.org)) High harmonic (HH) SPIDER setup — pulsed high harmonics are generated in non-linear interaction of a spectrally sheared pulse pair with a gas jet. Spectral interference is recorded with an XUV spectrometer

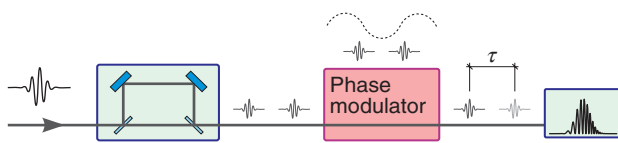

**Figure 11** (online color at [www.lphys.org](http://www.lphys.org)) Electro-optical spectral shearing interferometry — spectral shear between two delayed pulse replicas is generated in a temporal phase modulator by applying a linear temporal phase of opposite signs

pulse and then interferes with the strong local oscillator which provides a first interferogram. In a second step, the shear is changed by slightly changing the delay between the chirped ancilla and the test field and a second interferogram is recorded. The difference between the phases extracted from each interferogram directly gives access to the phase gradient  $\theta(\omega) = \phi(\omega - \Omega) - \phi(\omega)$ . No calibration of the delay is needed in this technique. These approaches allow researchers to measure much lower energy pulses [24], and have the potential for characterizing very broadband pulses.

Other SPIDER variants include a time domain version of SPIDER which eliminates the need for a spectrometer. First demonstrated in the near IR using a minimalist and versatile device (pulse shaper coupled to a two photon photodiode) [26], shown in Fig. 8, it has also been successfully implemented using conventional optics in the mid IR where spectrometers are not commonly available [27], shown in Fig. 9.

And in the quest to measure the shortest available pulses, High Harmonic SPIDER has been developed to characterize attosecond XUV pulses, shown in Fig. 10 [28–31]. In this scheme, two shaped pulses are used to generate XUV. A spectral shear in the two shaped pulses gives a spectral shear in the XUV pulses from high harmonic generation. The multiplication of the shear by the process enables pulses in the attosecond duration range to be characterized.

For pulses of more modest duration, non-stationary linear techniques will suffice. In fact, electro-optic tech-

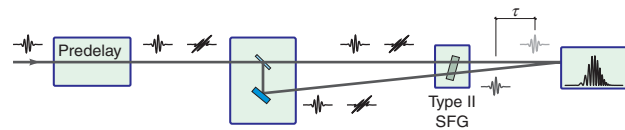

**Figure 12** (online color at [www.lphys.org](http://www.lphys.org)) The long crystal (LX) SPIDER (also known as ARAIGNEE) setup — the pre-delayed pulse copies of orthogonal polarizations are mixed in a nonlinear crystal cut for type II sum frequency generation while they propagate at slightly different angles relative to the optic axis. The differences of group velocities between ordinary and extraordinary pulses result in a pair of spectrally sheared copies of the measured pulse

niques have been used to generate the spectral shear for pulses greater than 200 fs [32,33], shown in Fig. 11. These linear techniques have the distinct advantage of being highly sensitive for low-power SPIDER applications.

## 6. Micro SPIDER

Most recently, a new approach to generating the spectral shear has led to a dramatic reduction in the overall footprint of SPIDER [34–36]. In this design, shown in Fig. 12, the spectral shear is generated by carefully engineered phase matching (PM) in a long nonlinear crystal. Asymmetric PM functions, with broad acceptance bandwidth for one state of polarization but narrow for the orthogonally polarized state, arise from a group velocity mismatch between the orthogonally polarized fundamental pulses together with a group velocity match between the upconverted pulse and one of the two fundamental pulses. The result of the highly asymmetric PM function is to select the ancilla frequency in the mismatched pulse spectrum with which the entire bandwidth of the other pulse is mixed, eliminating the requirement for a quasi-monochromatic ancillary pulse and the optical components to produce it. The exact frequency of the ancilla is determined by the angle of propagation through the crystal. Two beams at slightly different propagation angle will therefore generate spectrally sheared upconverted replica. The latest incarnation is the size of a compact USB spectrometer (roughly 9 cm × 6 cm), shown in the cover photo. In this image, the input ultrafast beam is shown in red, the upconverted beam is shown in blue. After passing through a quartz plate, the input beam is reflected from a split mirror which provides the time delay and two separate propagation angles through the nonlinear crystal. The upconverted beams then focus into the attached compact USB spectrometer. Similar to the two beam geometry, a focused beam will generate an upconverted replica showing a continuous variation of the central frequency with direction, and one can make the most of this feature to dramatically simplify the calibration compared to the two-beam arrangement [37].

## 7. Future

SPIDER has now indeed matured. Fifteen years of researching spectral shearing interferometry and ten years of improving SPIDER devices has helped scientists understand the problem of ultrashort pulse characterization; research groups worldwide have contributed clever new approaches to solving it. Signs of maturity are evident as SPIDER devices enter the commercial marketplace, yet does that mean that the pulse measurement problem is solved? Our answer is no, as there is much to do in the measurement regimes of few-cycle pulses, high harmonics and attosecond pulses, highly complex pulses (those with large time-bandwidth product), vexing issues associated with space-time coupling, and highly sensitive linear techniques such as electro-optic shearing. SPIDER at ten has indeed matured, but there is considerable room to grow.

*Acknowledgements* MEA acknowledges support from a Blasker grant. SPG acknowledges the support of the Fonds National de la Recherche Scientifique (F.R.S.-FNRS, Belgium). PW acknowledges the support of the Foundation for Polish Science (FNP) founded by a grant from Iceland, Liechtenstein, and Norway through the EEA Financial Mechanism. MEA, PW, and IAW were supported by EPSRC. AM was supported by EPSRC and the European commission through the RTN XTRA. IAW acknowledges discussions with Christophe Dorrer.

## References

- [1] V.A. Zubov and T.I. Kuznetsova, *Sov. J. Quantum Electron.* **21**, 1285–1286 (1991).
- [2] V. Wong and I.A. Walmsley, *Opt. Lett.* **19**, 287–289 (1994).
- [3] C. Iaconis and I.A. Walmsley, *Opt. Lett.* **23**, 792–794 (1998).
- [4] C. Iaconis and I.A. Walmsley, *IEEE J. Quantum Electron.* **35**, 501–509 (1999).
- [5] <http://ultrafast.physics.ox.ac.uk/spider/>.
- [6] C. Dorrer, *J. Opt. Soc. Am. B* **16**, 1160–1168 (1999).
- [7] C. Dorrer and I.A. Walmsley, *J. Opt. Soc. Am. B* **19**, 1019–1029 (2002).
- [8] C. Dorrer and I.A. Walmsley, *J. Opt. Soc. Am. B* **19**, 1030–1038 (2002).
- [9] A. Wyatt, *Spectral Interferometry for the Complete Characterization of Near Infrared Femtosecond and Extreme Ultraviolet Attosecond Pulses*, D. Phil. thesis (University of Oxford, Oxford, 2007).
- [10] P. Londero, M.E. Anderson, C. Radzewicz, C. Iaconis, and I.A. Walmsley, *J. Mod. Opt.* **50**, 179–184 (2003).
- [11] L. Gallmann, D.H. Sutter, N. Matuschek, G. Steinmeyer, U. Keller, C. Iaconis, and I.A. Walmsley, *Opt. Lett.* **24**, 1314–1316 (1999).
- [12] G. Stibenz and G. Steinmeyer, *Opt. Express* **12**, 6319–6325 (2004).
- [13] G. Stibenz and G. Steinmeyer, *Rev. Sci. Instr.* **77**, 073105 (2006).
- [14] P. Baum, S. Lochbrunner, and E. Riedle, *Opt. Lett.* **29**, 210–212 (2004).
- [15] P. Baum and E. Riedle, *J. Opt. Soc. Am. B* **22**, 1875–1883 (2005).
- [16] E.M. Kosik, A.S. Radunsky, I.A. Walmsley, and C. Dorrer, *Opt. Lett.* **30**, 326–328 (2005).
- [17] A.S. Wyatt, I.A. Walmsley, G. Stibenz, and G. Steinmeyer, *Opt. Lett.* **31**, 1914–1916 (2006).
- [18] J.R. Birge, R. Ell, and F.X. Kärtner, *Opt. Lett.* **31**, 2063–2065 (2006).
- [19] T. Shuman, I.A. Walmsley, L. Waxer, M. Anderson, C. Iaconis, and J. Bromage, *Opt. Express* **5**, 134–143 (1999).
- [20] C. Dorrer, B. de Beauvoir, C. Le Blanc, S. Ranc, J.-P. Rousseau, P. Rousseau, J.-P. Chambaret, and F. Salin, *Opt. Lett.* **24**, 1644–1646 (1999).
- [21] W. Kornelis, J. Biegert, J.W.G. Tisch, M. Nisoli, G. Sansone, C. Vozzi, S. De Silvestri, and U. Keller, *Opt. Lett.* **28**, 281–283 (2003).
- [22] M.E. Anderson, L.E.E. de Araujo, E.M. Kosik, and I.A. Walmsley, *Appl. Phys. B* **70**, S85–S93 (2000).
- [23] S. Jensen and M.E. Anderson, *Appl. Opt.* **43**, 883–893 (2004).
- [24] M. Hirasawa, N. Nakagawa, K. Yamamoto, R. Morita, H. Shigekawa, and M. Yamashita, *Appl. Phys. B* **74**, S225–S229 (2002).
- [25] C. Dorrer, P. Londero, and I.A. Walmsley, *Opt. Lett.* **26**, 1510–1512 (2001).
- [26] A. Monmayrant, M. Joffre, T. Oksenhendler, R. Herzog, D. Kaplan, and P. Tournois, *Opt. Lett.* **28**, 278–280 (2003).
- [27] C. Ventalon, J.M. Fraser, and M. Joffre, *Opt. Lett.* **28**, 1826–1828 (2003).
- [28] F. Quéré, J. Itatani, G.L. Yudin, and P.B. Corkum, *Phys. Rev. Lett.* **90**, 073902 (2003).
- [29] E. Cormier, I.A. Walmsley, E.M. Kosik, A.S. Wyatt, L. Corner, and L.F. DiMauro, *Phys. Rev. Lett.* **94**, 033905 (2005).
- [30] Y. Mairesse, O. Gobert, P. Breger, H. Merdji, P. Meynadier, P. Monchicourt, M. Perdrix, P. Salières, and B. Carré, *Phys. Rev. Lett.* **94**, 173903 (2005).
- [31] E.M. Kosik, L. Corner, A.S. Wyatt, E. Cormier, I.A. Walmsley, and L.F. DiMauro, *J. Mod. Opt.* **52**, 361–378 (2005).
- [32] I. Kang, C. Dorrer, and F. Quochi, *Opt. Lett.* **28**, 2264–2266 (2003).
- [33] C. Dorrer and I. Kang, *Opt. Lett.* **28**, 477–479 (2003).
- [34] A.S. Radunsky, E.M. Kosik Williams, I.A. Walmsley, P. Wasylczyk, W. Wasilewski, A.B. U'Ren, and M.E. Anderson, *Opt. Lett.* **31**, 1008–1010 (2006).
- [35] A.S. Radunsky, I.A. Walmsley, S.-P. Gorza, and P. Wasylczyk, *Opt. Lett.* **32**, 181–183 (2007).
- [36] S.-P. Gorza, A.S. Radunsky, P. Wasylczyk, and I.A. Walmsley, *J. Opt. Soc. Am. B* **24**, 2064–2074 (2007).
- [37] S.P. Gorza, P. Wasylczyk, and I.A. Walmsley, *Opt. Express* **15**, 15168–15174 (2007).